



# Foundation Catalog



## ABOUT DRILLINGWORLD

DrillingWorld has been in business for 23 years. We started our business with a commitment to customer satisfaction. We have expanded our great customer care staff and will continue to improve our business by listening to our customer needs.

Our goal is making your business successful by providing you with the best quality tools.

We look forward to working with you.

### DrillingWorld Services

- Drilling Tools
- Augers
- Auger Teeth
- Extensions
- Auger Drills & Motors
- Custom Augers
- Large Bullet Tooth Inventory
- Same Day shipping on most orders
- Free GroundFreight on any order over \$500 (Continental U.S)
- Quality Products
- Competitive prices

Over 40,000 sq/ft of in stock drilling & trenching equipment

### Office Hours:

Monday through Friday  
6:00 a.m. to 4:00 p.m. P.S.T.

### Will Call Hours:

6:30 a.m. to 3:30 p.m. P.S.T.

### Contact Information

Email: [sales@drillingworld.com](mailto:sales@drillingworld.com)  
Phone: (800) 331-9988  
Fax : (510) 895-8129

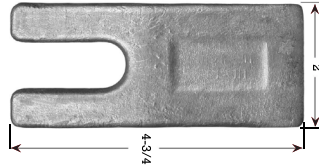
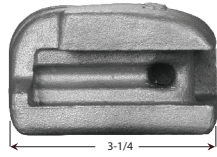
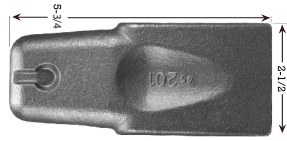
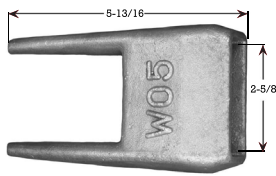

## Taper Fit Teeth & Pockets

1

## Pengo® Style Teeth & Pockets

2



## Hensley Teeth & Shanks

3

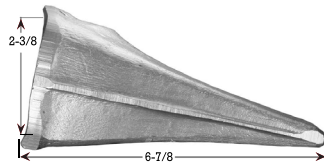

## Esco Top Pin Style Teeth & Shanks

4

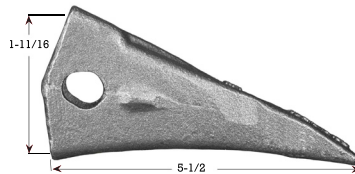
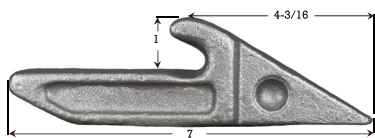

## H&L Style Teeth & Shanks

5

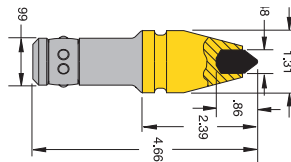
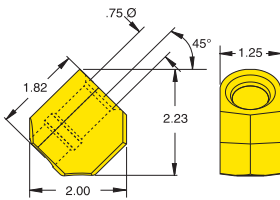

## Bullet Bits & Blocks

6

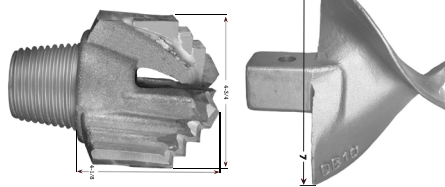

## Dirt & Rock Augers Pilot Bits Drag & Tri-Cone Bits

7

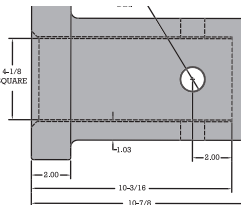

## Kelly Boxes

8

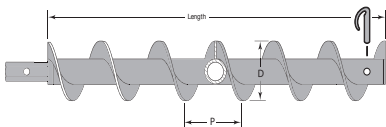

## Continuous Flight Augers & Cutterheads

9

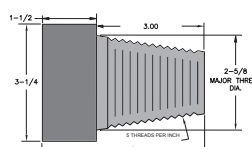
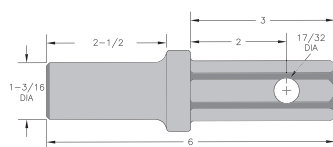

## Hex Shanks, Sockets, API Tool Joints

10





# 201 Series Teeth

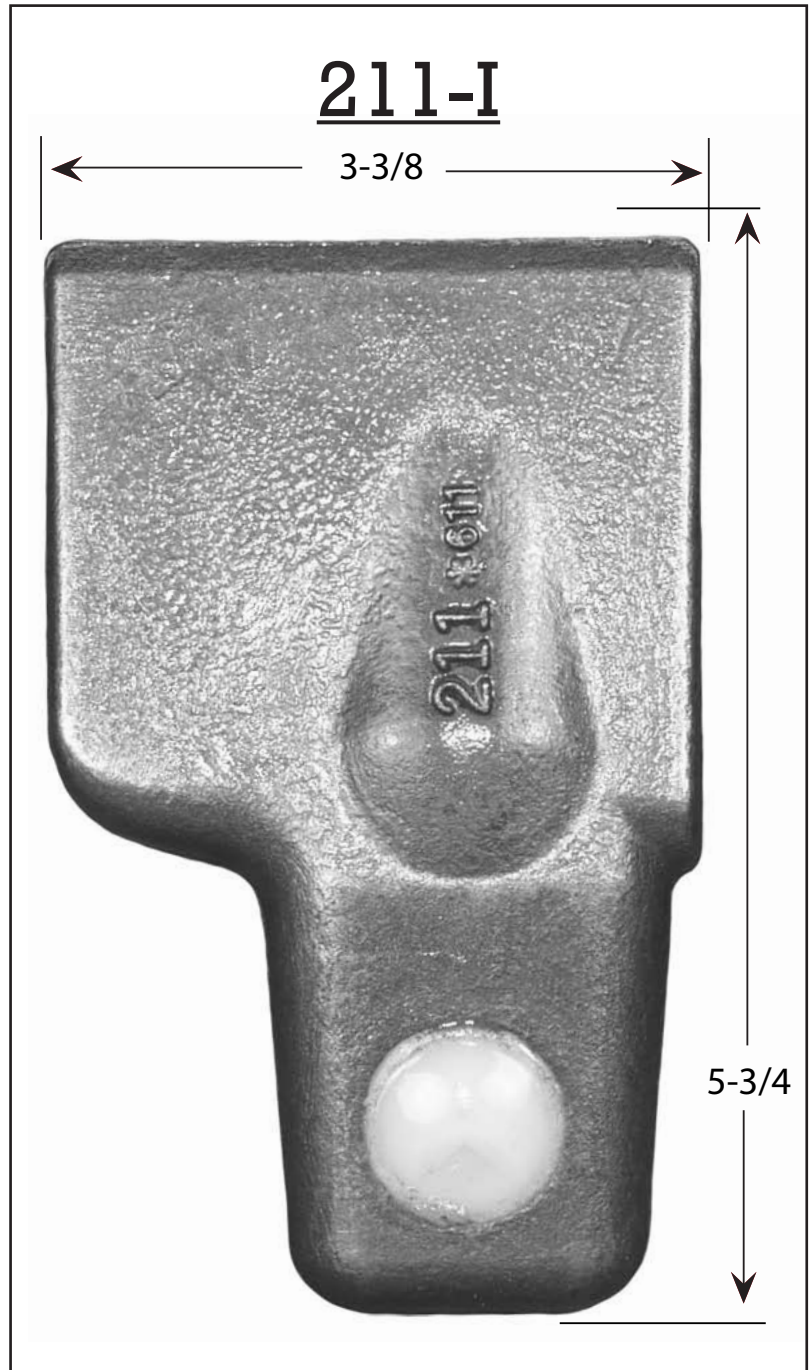
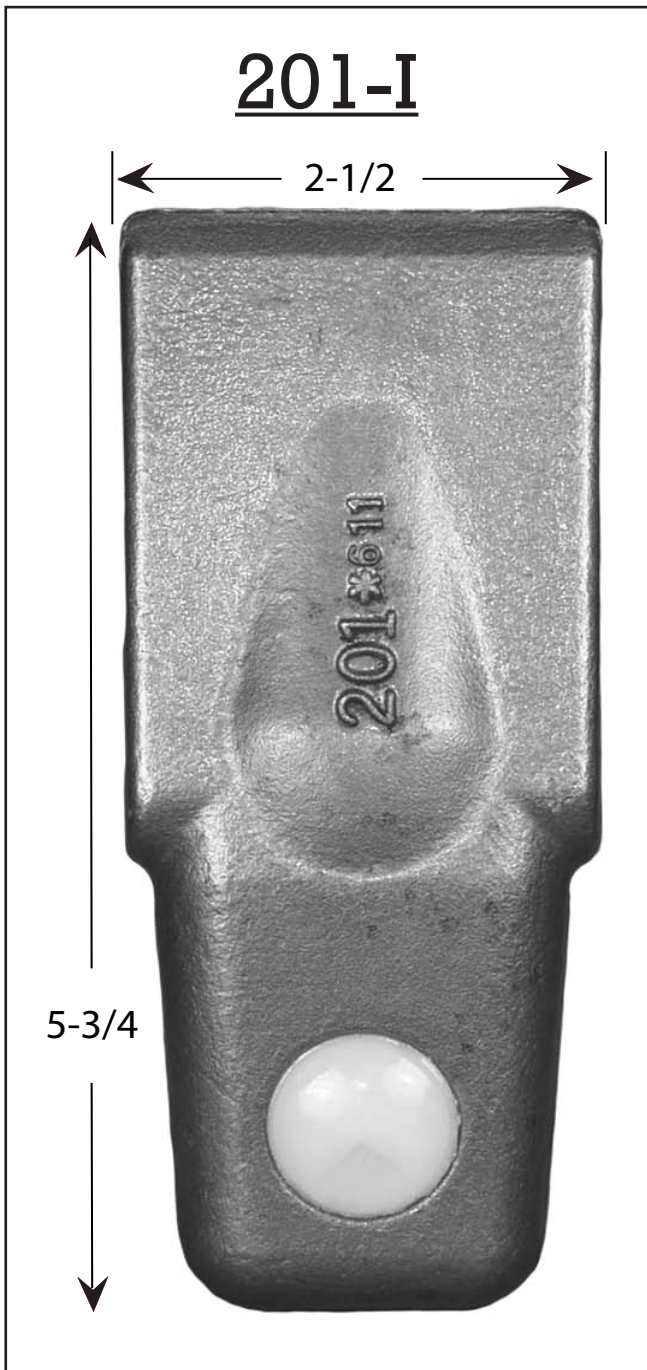

Description	Part No.	Unit lbs.	Pocket
Dirt Tooth	201-I	2.1	WO5-I
Clearance Cutter	211-I	2.9	WO8-I WO9-I

# 201 Series Teeth

132-I



Description	Part No.	Unit lbs.	Pocket
Dirt Tooth	132-I	3.2	WO5-I WO8-I WO9-I

# 201 Series Teeth

134-I

5-1/8

Reinforced  
gauge edge  
for extra wear

5" wide cutting edge  
with a 2" offset

6

Description	Part No.	Unit lbs.	Pocket
Clearance Tooth	134-I	3.5	WO5-I WO8-I WO9-I



# 201 Series Teeth

**TC 212**

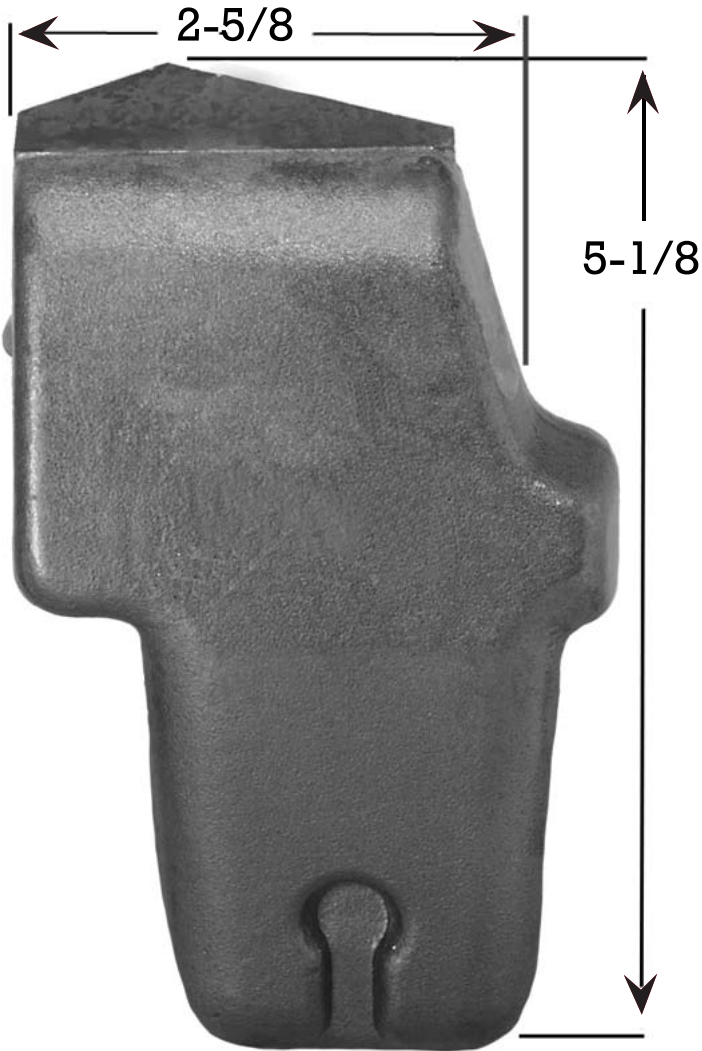

**299**



Description	Part No.	Unit lbs.	Pocket
Carbide Tooth	TC212	2.5	WO5-I
Carbide for rock abrasion	299	2.8	WO8-I WO9-I

# 201 Series Tooth Pocket

WO5-I

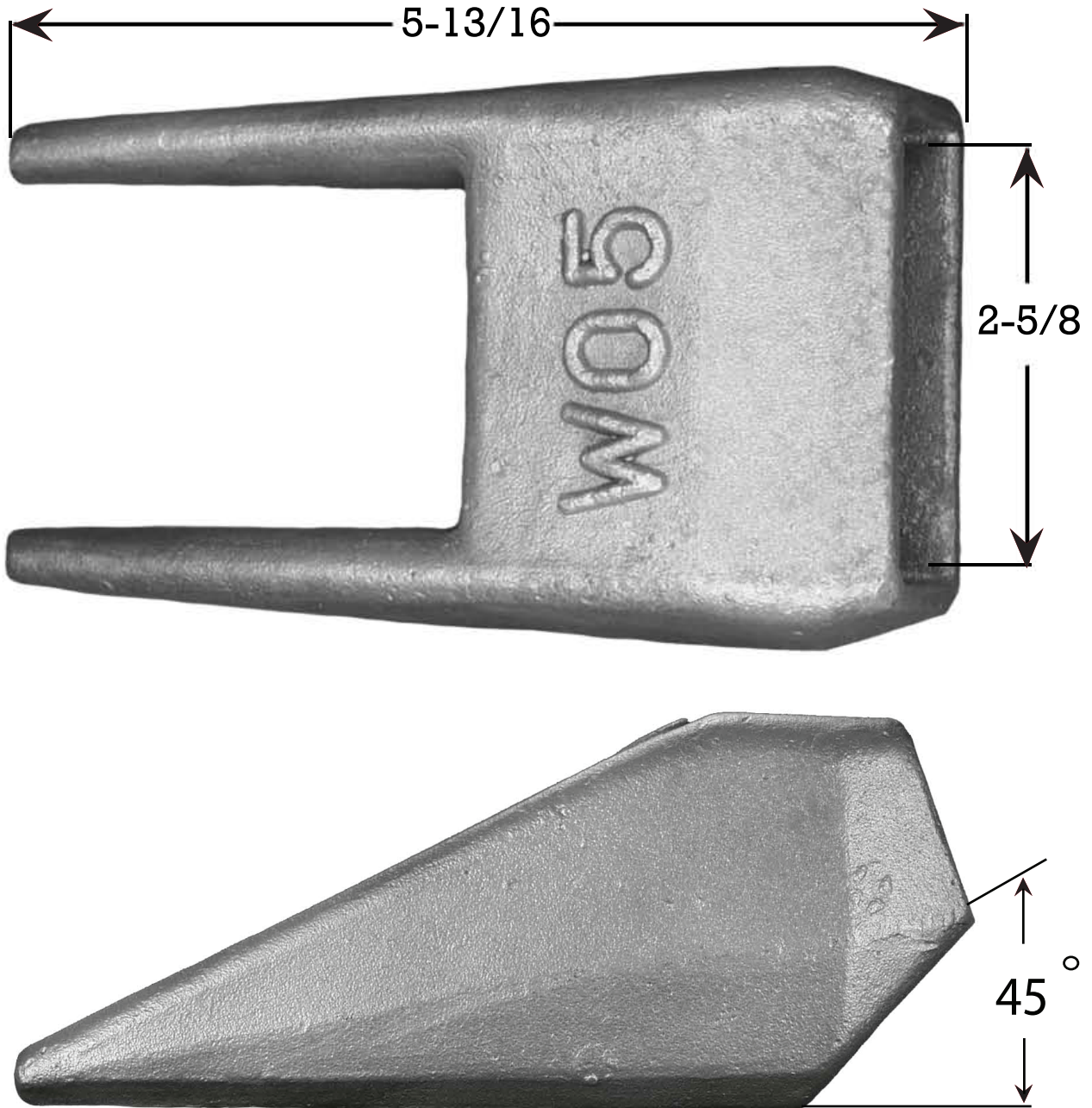

Description	Part No.	Tooth Fitment	Tooth Angle	Unit lbs.
Pocket	WO5-I	201 Series	45°	3.6

# 201 Series Tooth Pocket

## W08-I

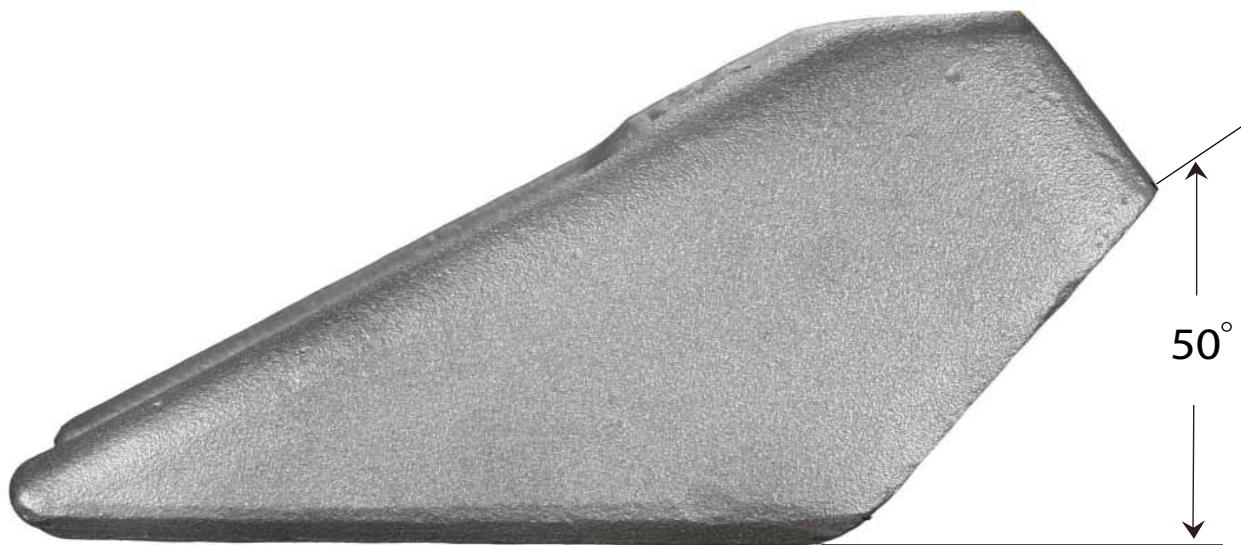

Description	Part No.	Tooth Fitment	Tooth Angle	Unit lbs.
Pocket	W08-I	201 Series	50°	4.8



# 201 Series Tooth Pocket

## WO9-I

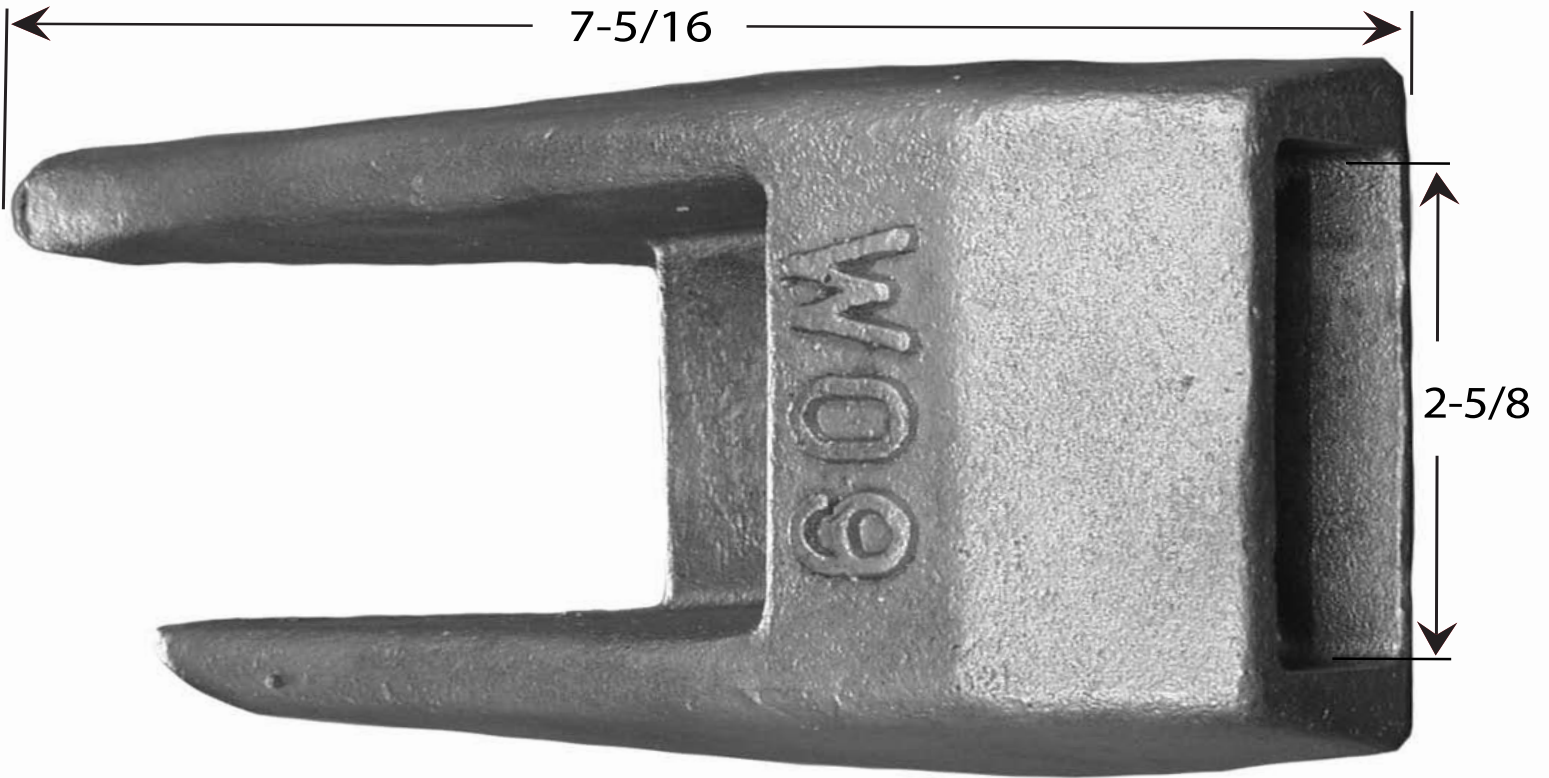

Description	Part No.	Tooth Fitment	Tooth Angle	Unit lbs.
Pocket	WO9-I	201 Series	54°	7.0

# 80 Series Teeth

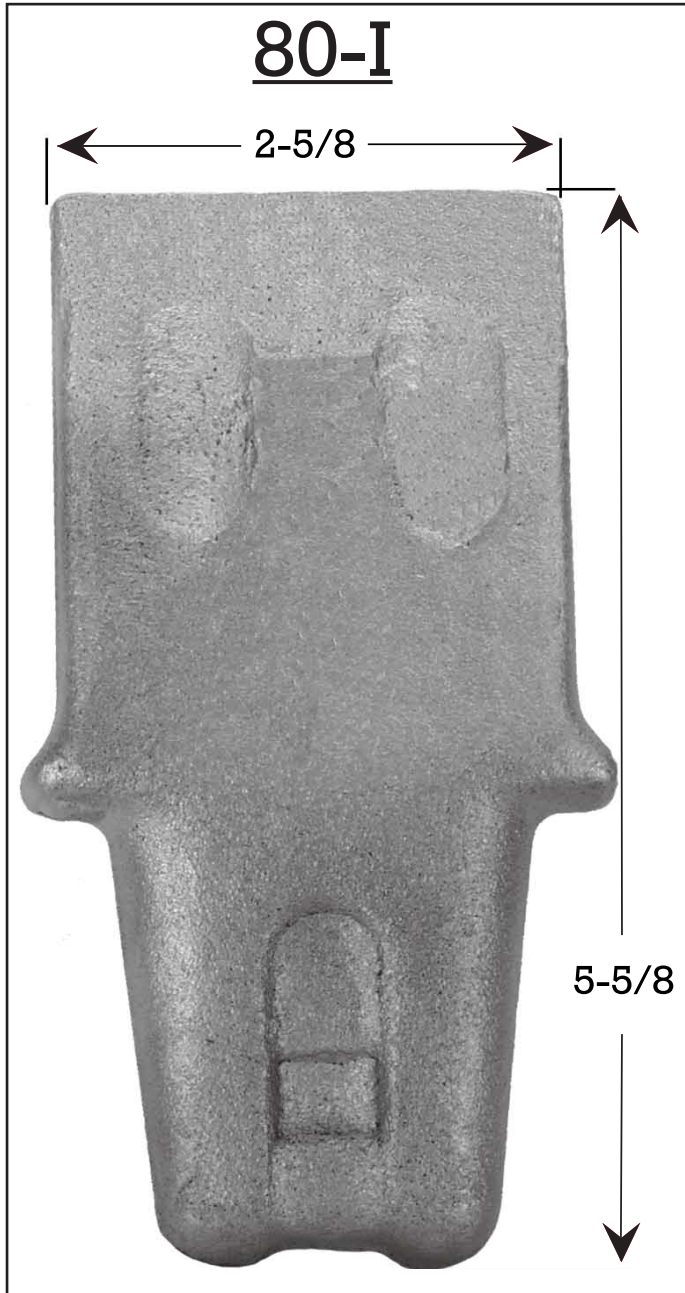

Description	Part No.	Unit lbs.	Pocket
Dirt Tooth	80-I	2.0	W12-I
Carbide Tooth	80C-I	2.4	4HD-I 9P-I

# 80 Series Tooth Pocket

## 4HD-I

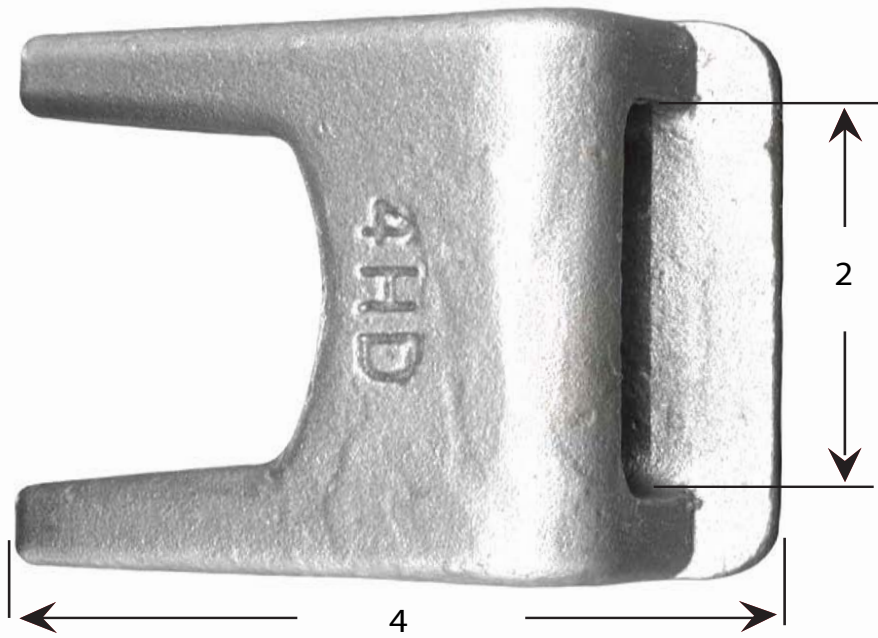

Description	Part No.	Tooth Fitment	Tooth Angle	Unit lbs.
Pocket	4HD-I	80 Series	15°	2.15



# 60 Series Teeth

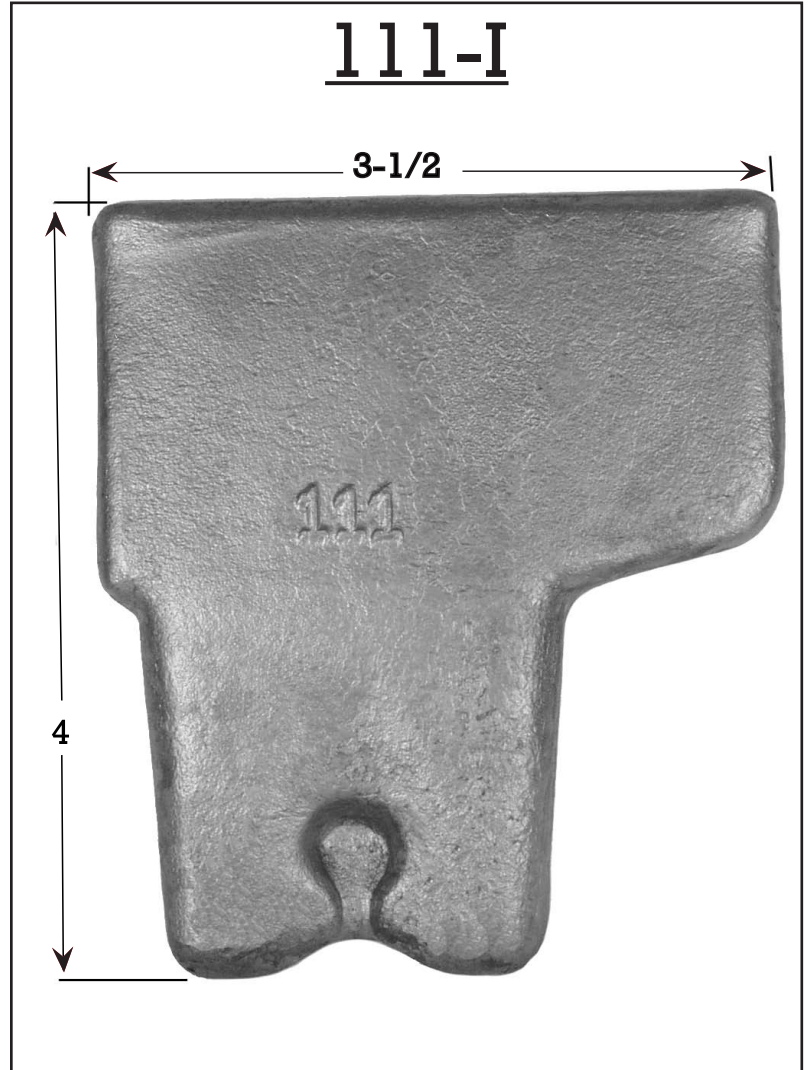
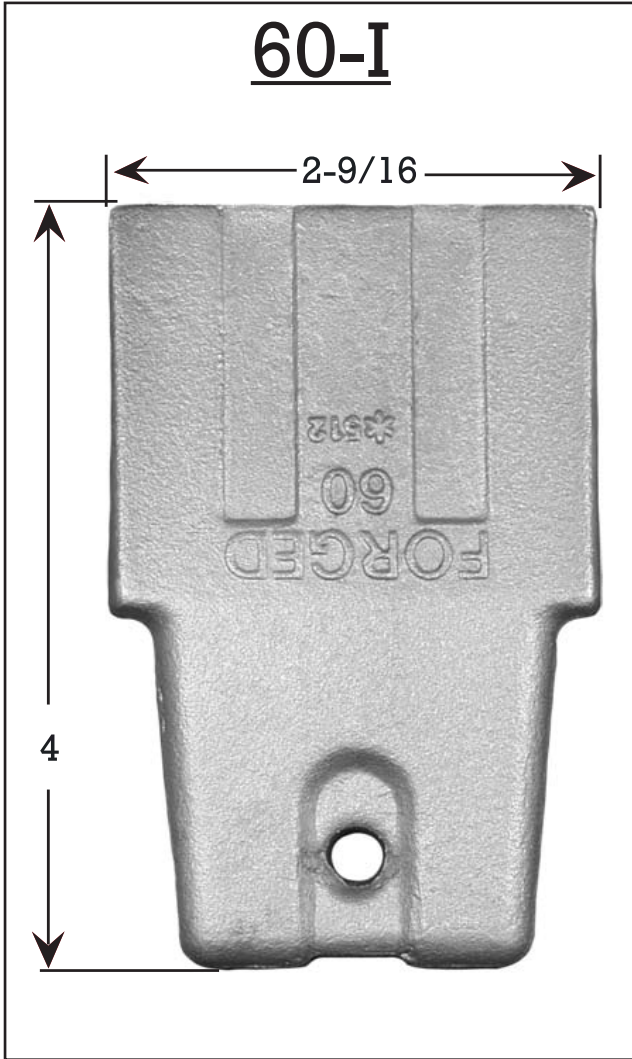

Description	Part No.	Unit lbs.	Pocket
Dirt Tooth	60-I	0.8	WO1-I WO2-I
Dirt Tooth	111-I	1.1	2HD-I

# 60 Series Teeth

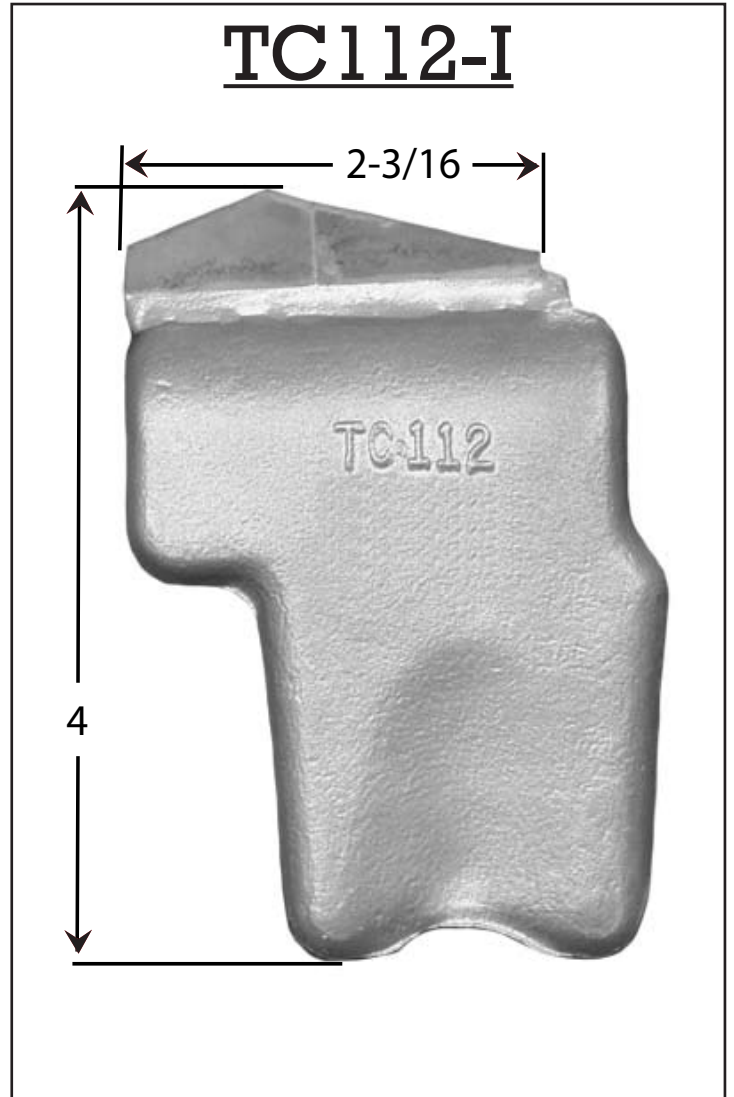
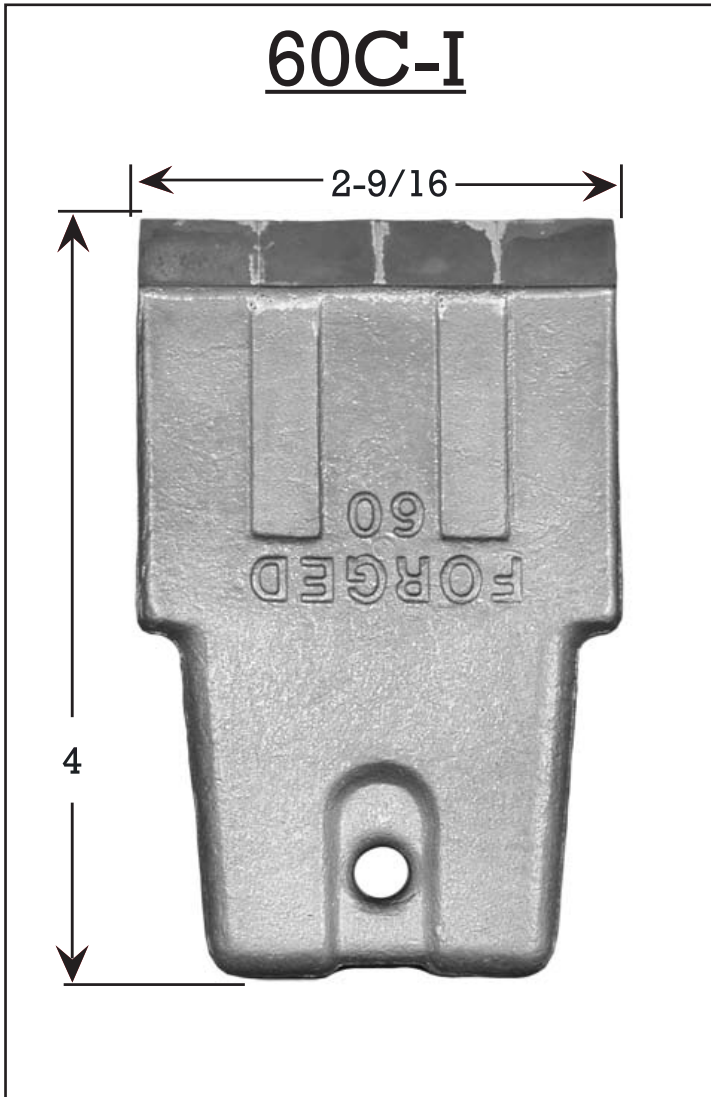

Description	Part No.	Unit lbs.	Pocket
Carbide Tooth	TC112	1.4	WO1-I WO2-I
Carbide Tooth	60C-I	1.0	2HD-I

# 60 Series Tooth Holders

## W01-I



Description	Part No.	Tooth Fitment	Tooth Angle	Unit lbs.
Holder	W01-I	60 Series	10°	1.2



# 60 Series Tooth Holders

## WO2-I

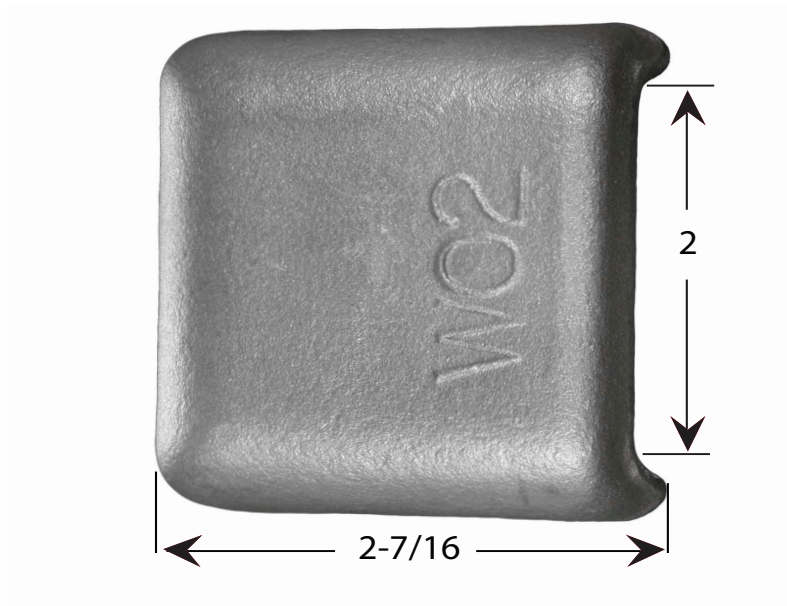

Description	Part No.	Tooth Fitment	Tooth Angle	Unit lbs.
Weld-On Holder	WO2-I	60 Series	0	.8

# 60 Series Tooth Pocket

## 2HD-I

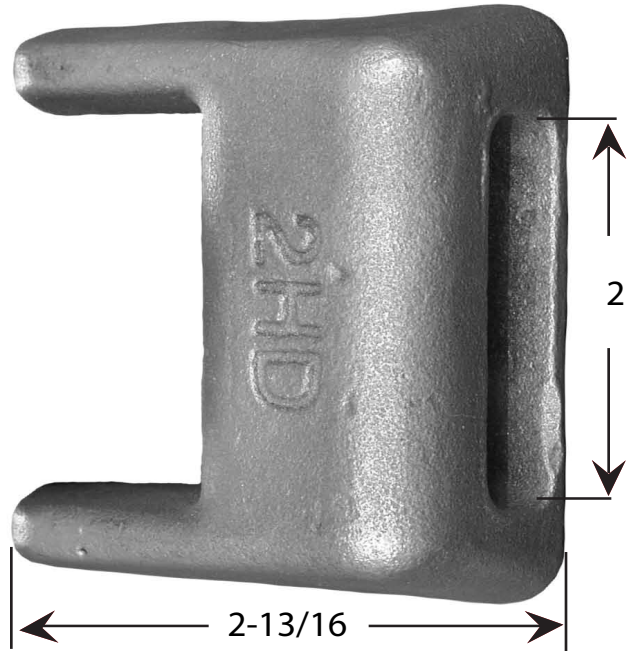

Description	Part No.	Tooth Fitment	Tooth Angle	Unit lbs.
Pocket	2HD-I	60 Series	$30^\circ$	1.6